

**+15 power supply extension for**

**L200 (SU) Series 6 Club/Double cab 09/2019 >> Part No: MT-166-ZZU**

## Electric wiring kit for towbars / 13-pin / 12 Volt / ISO 11446 Fitting instructions

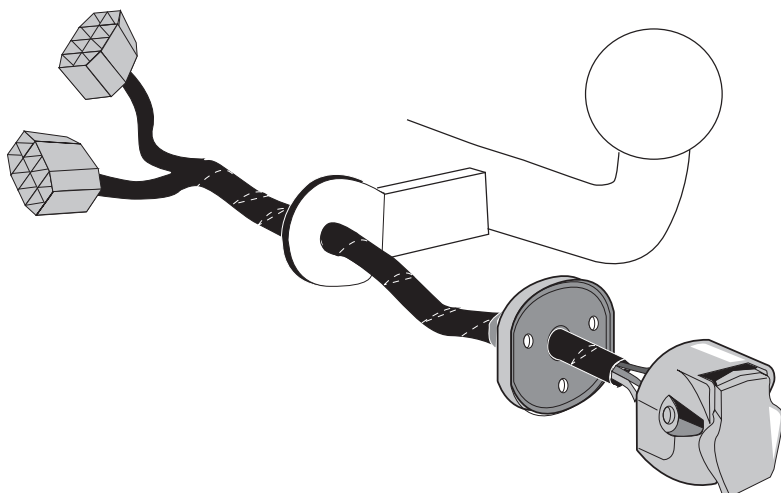

### IMPORTANT!

This electric kit has to be installed by a professional workshop or a suitably qualified person. The installation instructions must have been read and fully understood before the start of any installation. Please contact your wiring kit provider should you need assistance!

Make sure the vehicle is approved/homologated by the manufacturer, to tow a trailer! Also please check that there is a definite compatibility between this vehicle and the electric kit!

Following installation of the electric kit, the installation instructions must be kept together with the vehicle's service documents! They contain important information for any repeated diagnosis or activation processes that may be necessary in future!

All warranty claims will be forfeited if the electric kit or components contained therein are used incorrectly or modified.

When driving without a trailer or load carrier, any adapters that have been must always be unplugged from the socket.

If the trailer or load carrier is not equipped with a fog lamp, depending on the vehicle type, the correct function of the towing kit cannot be guaranteed. In such cases, a fog lamp should be retro fitted.

We cannot provide extended warranty or guarantee this kit if any technical electrical modifications or software updates have been performed after initial vehicle delivery, which may in themselves, cause malfunctions in the trailer socket or any trailer electrical equipment

Depending on the type of trailer module used in this electric kit, diagnostic interrogation with the vehicle's electrical system may be limited or will not function. Therefore, the error memory inside the module may not be able to be accessed. Error logs relating to the trailer module that may be generated in the vehicle network as a result of a test procedure, may be due to the incorrect installation of this kit or false activation of the trailer connection system.

**We ALWAYS recommend whenever possible, the following troubleshooting process:**

- An analysis of the vehicle's error memory and possibly clearing of all faults **BEFORE** the start of the installation!
- Try disconnecting the trailer module from the towing harness and re-start the fault clearing process!
- If in doubt, limit the time for troubleshooting and call our Technical Support Team!

Please follow our instructions carefully and always test the towing electrics using a true lighting board or a specifically designed bulb tester. If an LED tester is used, ensure it is equipped with correct load resistors or malfunctions will occur!

This instruction is subject to changes and we reserve the right to make changes to design, colour etc. All of the data and illustrations may not be an exact representation but the text contained in this instructions **MUST BE OBSERVED!**

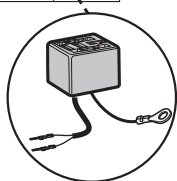
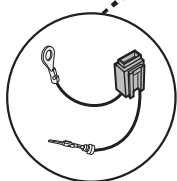
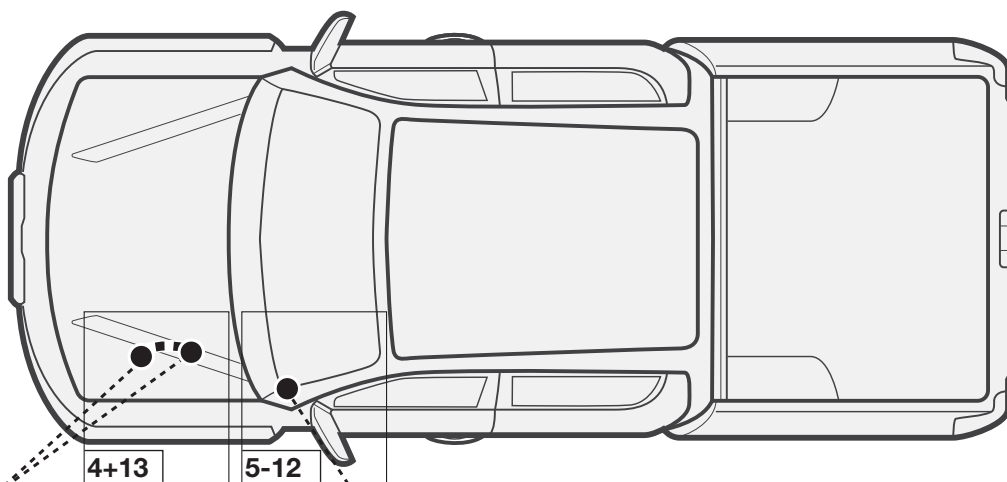
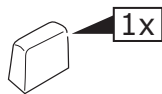
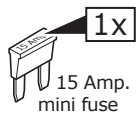
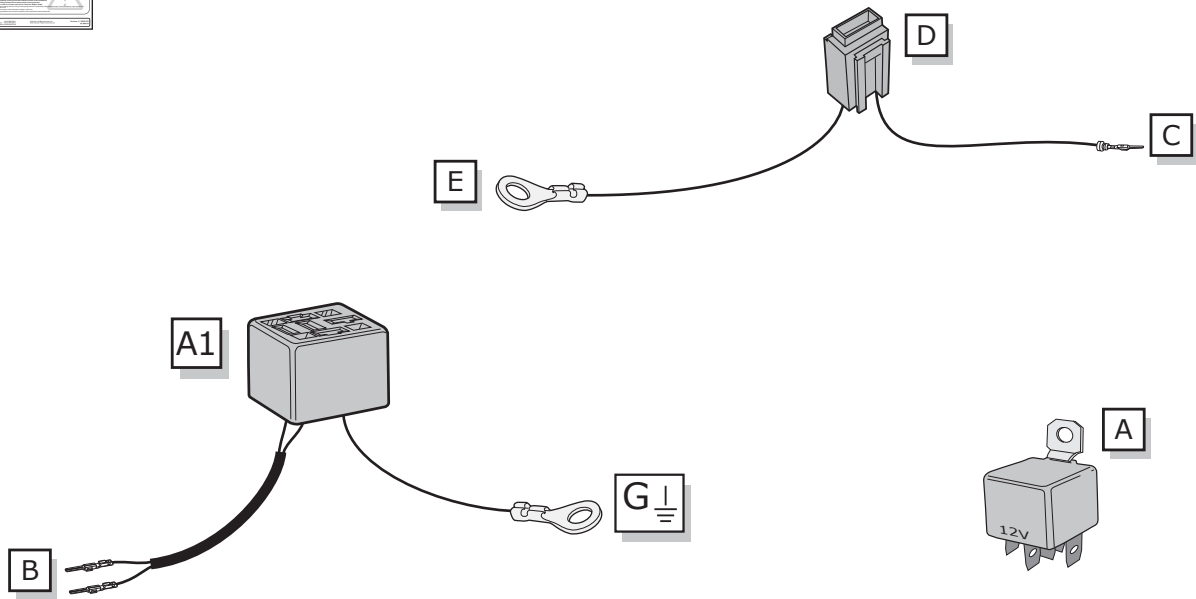

## SYMBOL EXPLANATION

	Left (58-L) respectively Right (58-R) tail light
54	Stop light (54) / high mounted, third stop light (54)
	Turn signal indicator left
	Turn signal indicator right
	Rear fog light(s)
	Reversing light(s)
	Permanent power supply / 13pin socket, chamber 9
	Charging wire for trailer battery / 13pin socket, chamber 10
	Trailer / trailer recognition
	Permanent current power supply
	Ground or Earth (31)
	Ground connection battery terminal lug
	Positive connection battery terminal lug

	Cigarette lighter / accessory socket
	Loudspeaker / buzzer
	Park Distance Control
	Switch / source of function
	Connect together
	Disconnect
	Look at / See further information
	Look carefully at selected area
	Present / Occupied / OK
	Not present / Not occupied / Not OK
	Acoustic indication
	Attention / important advice
	Fuse / fuse capacity 20 Ampère

## TOOLS

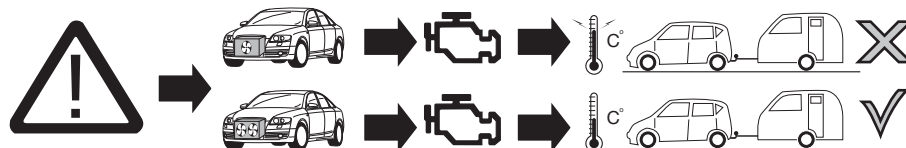
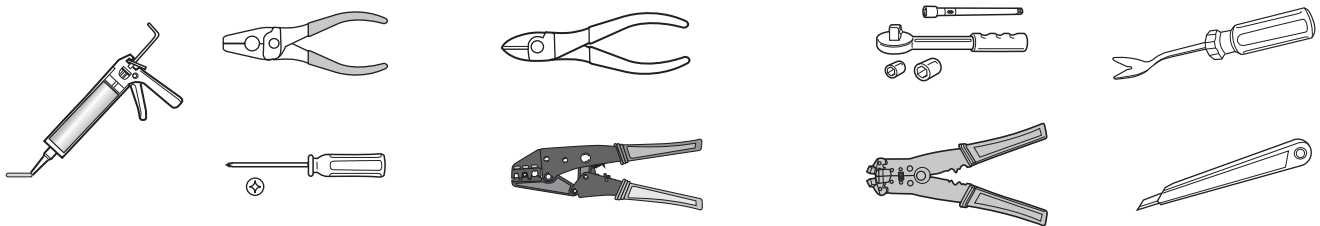

## ATTENTION!

The vehicle's cooling capacity may have to be increased when retrofitting a trailer coupling!  
You must observe the manufacturer's instructions!!

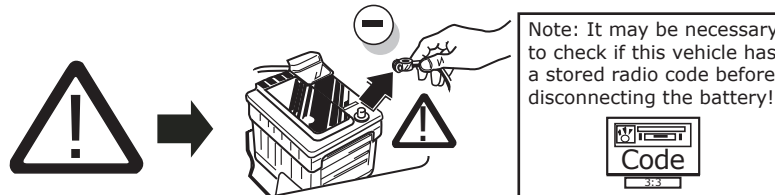

## ATTENTION!

In order to avoid mal-functions and damage to the vehicle's electrical system the earth terminal **must be disconnected** from the vehicle's battery **before starting work!**

Both the trailer module and the vehicle's control unit for the electrical system can be damaged during work on the data bus connections if the battery is not disconnected!

1

Please pay attention to the manufacturer's instructions when disconnecting and reconnecting the vehicle's battery!

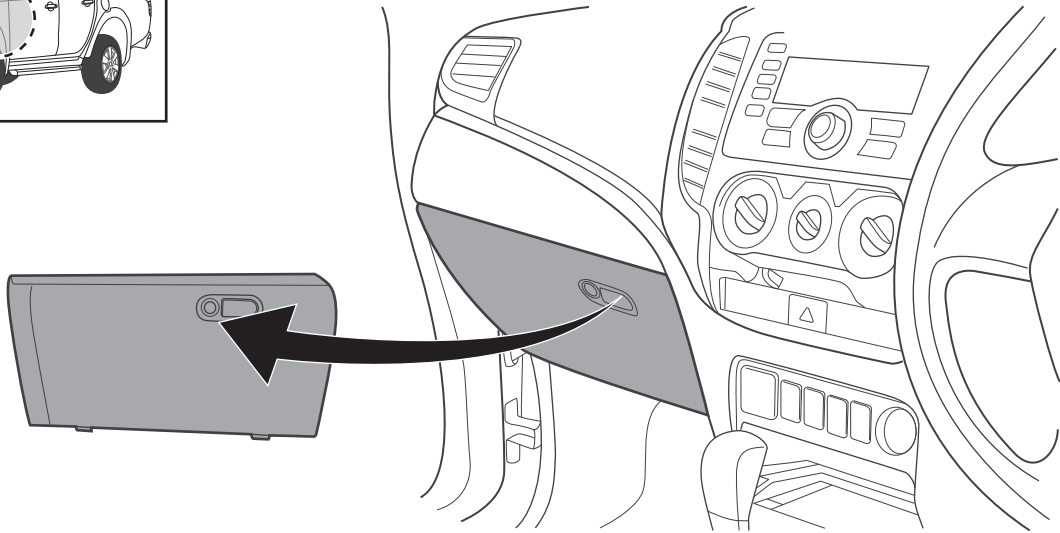
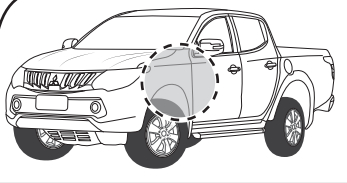

2

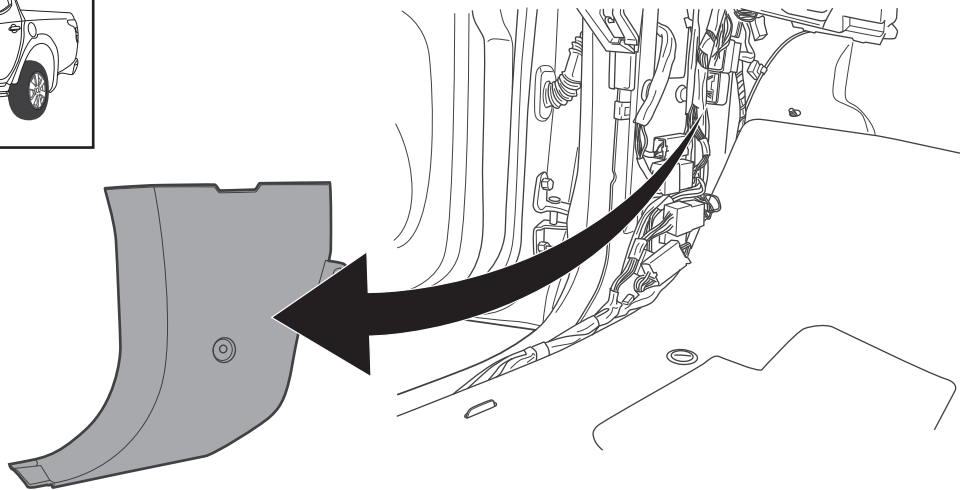
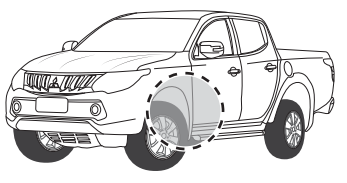

3

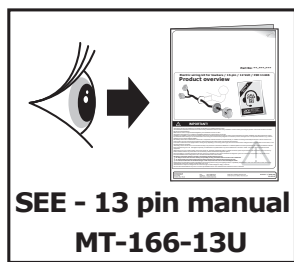
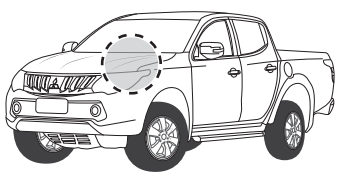

SEE - 13 pin manual  
MT-166-13U

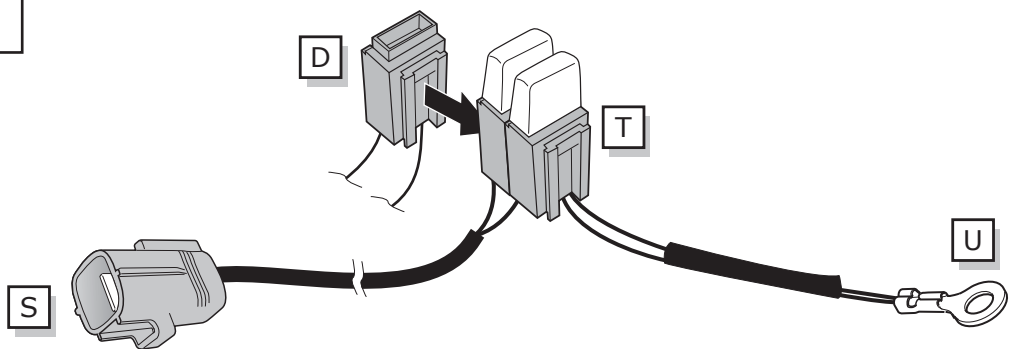

4

1

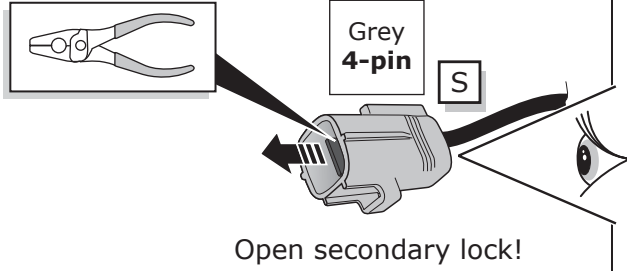

2

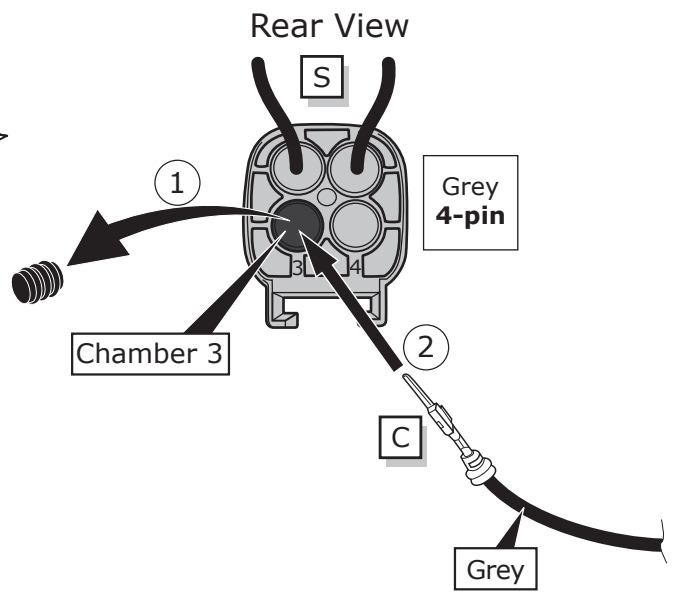

3

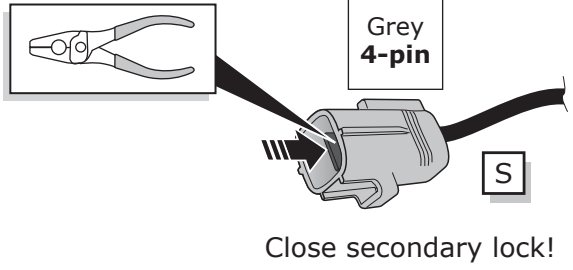

5

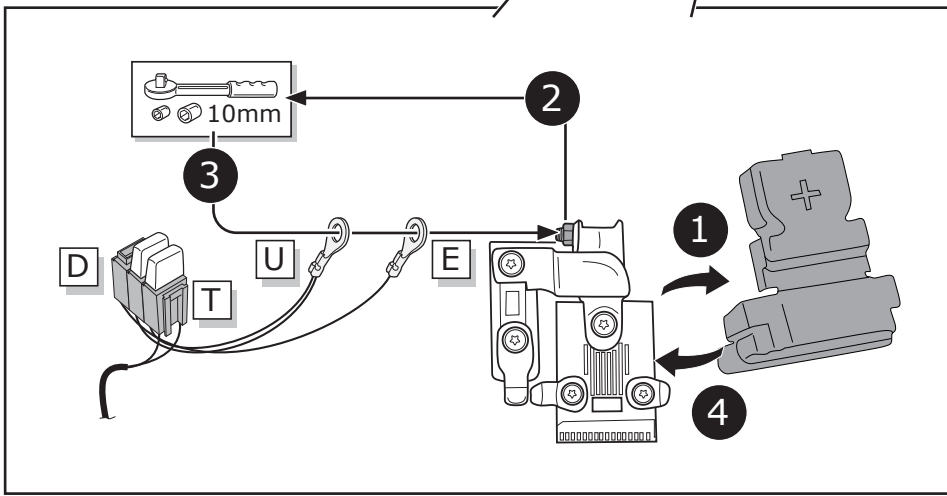
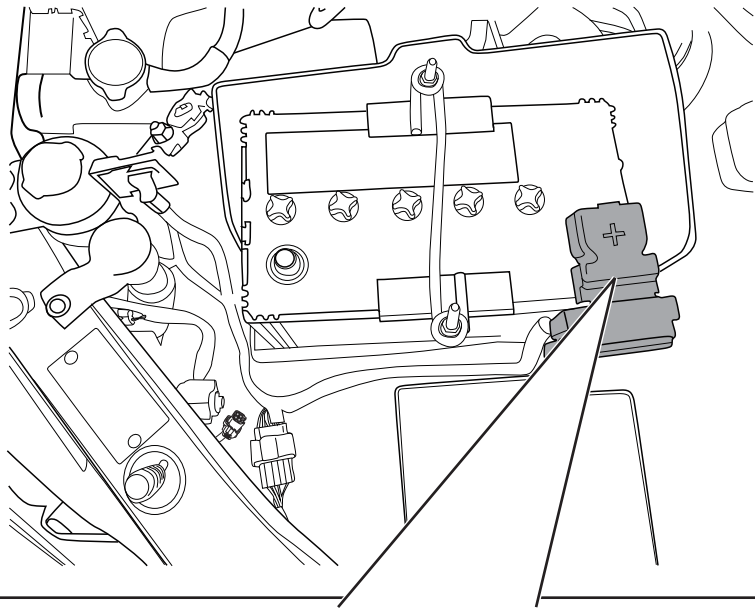
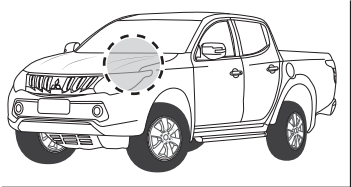

6

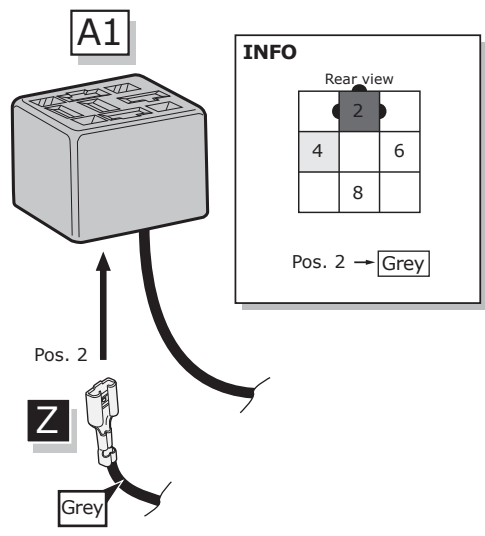
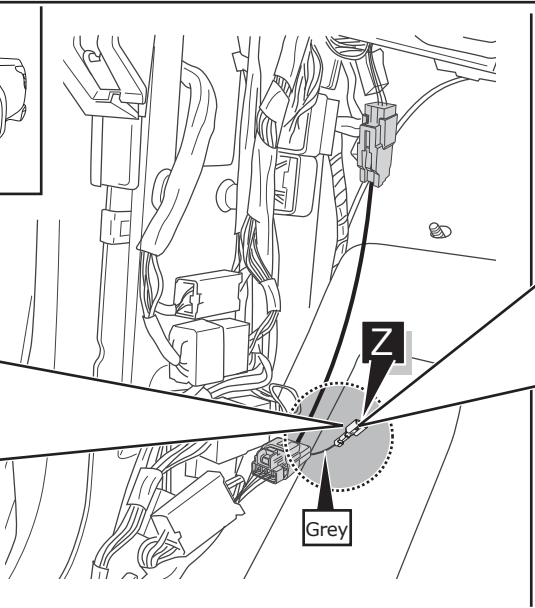
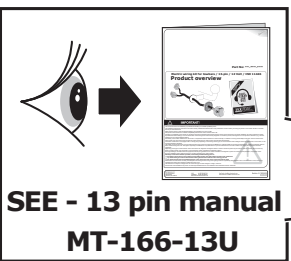
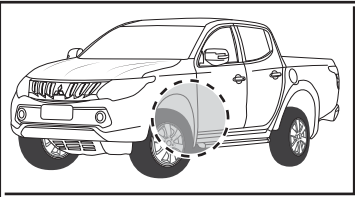
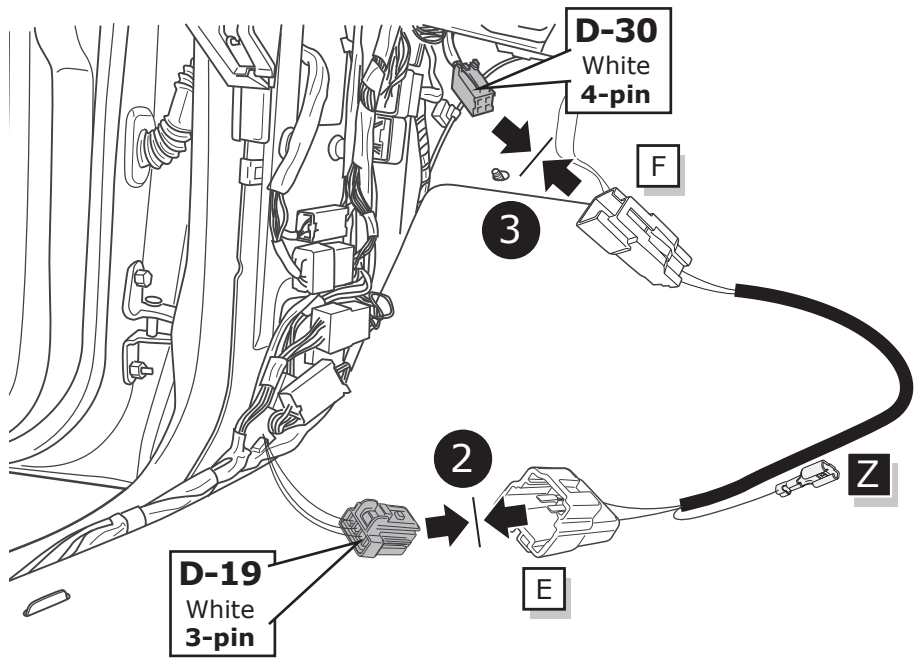
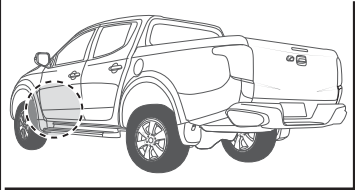
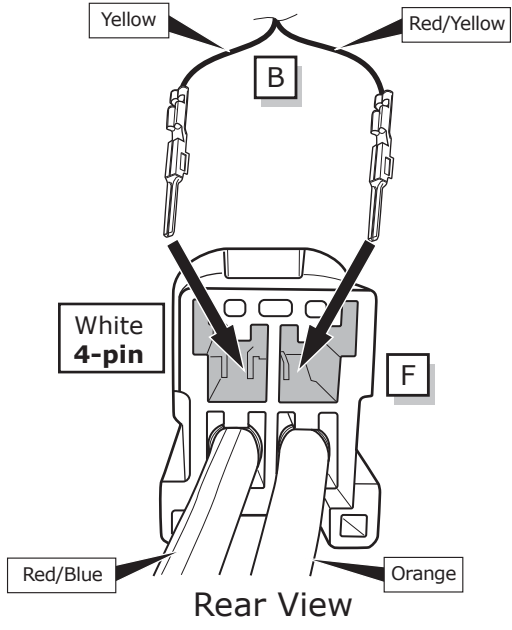
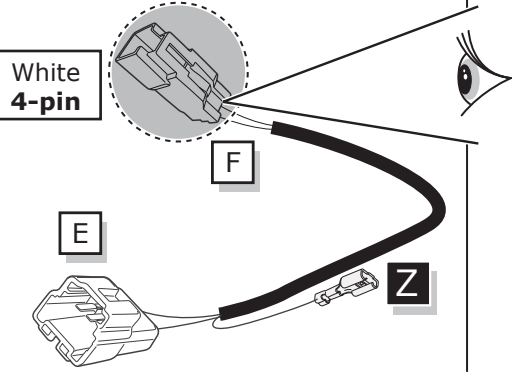
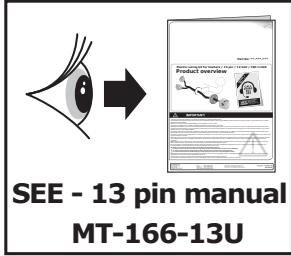

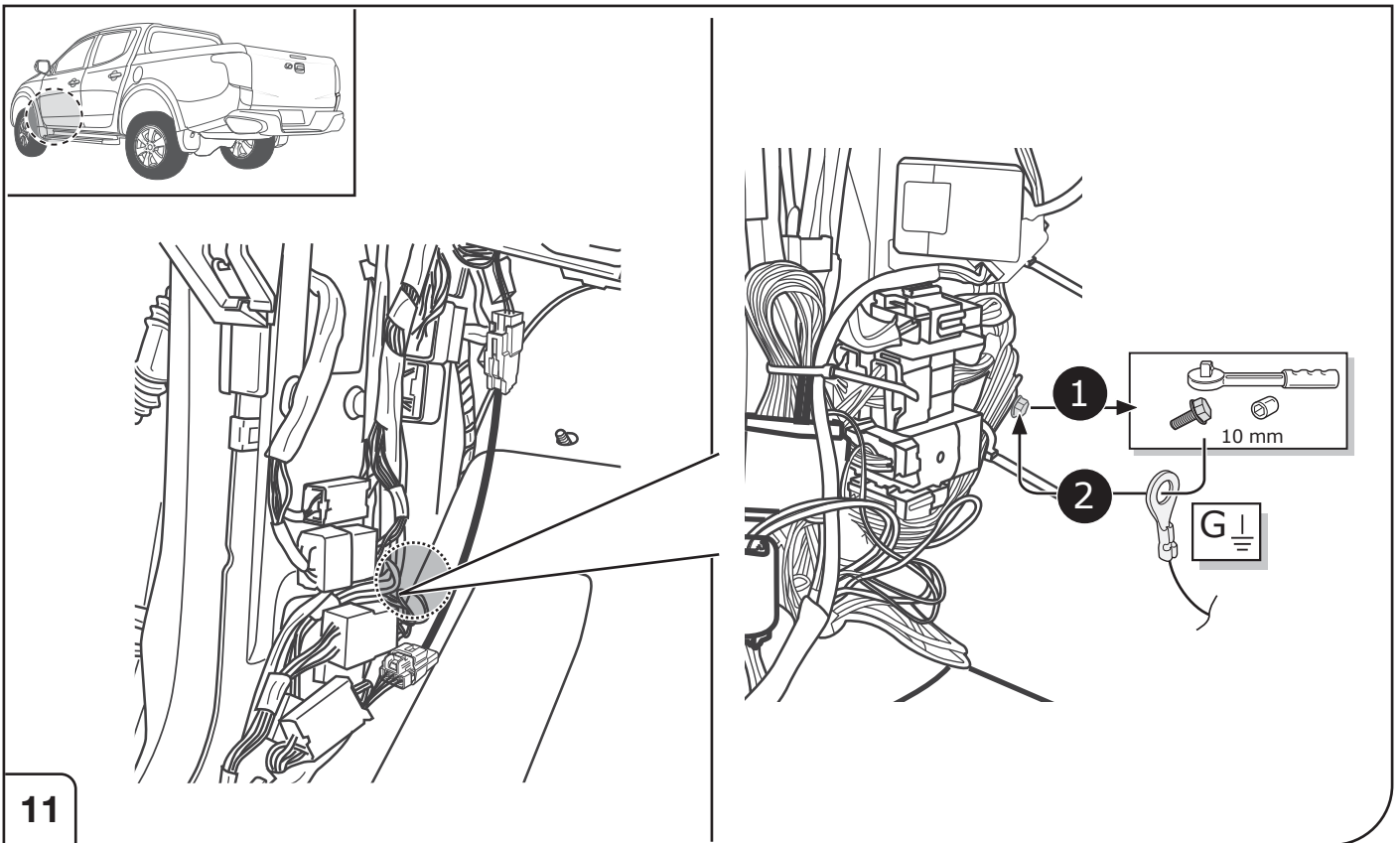
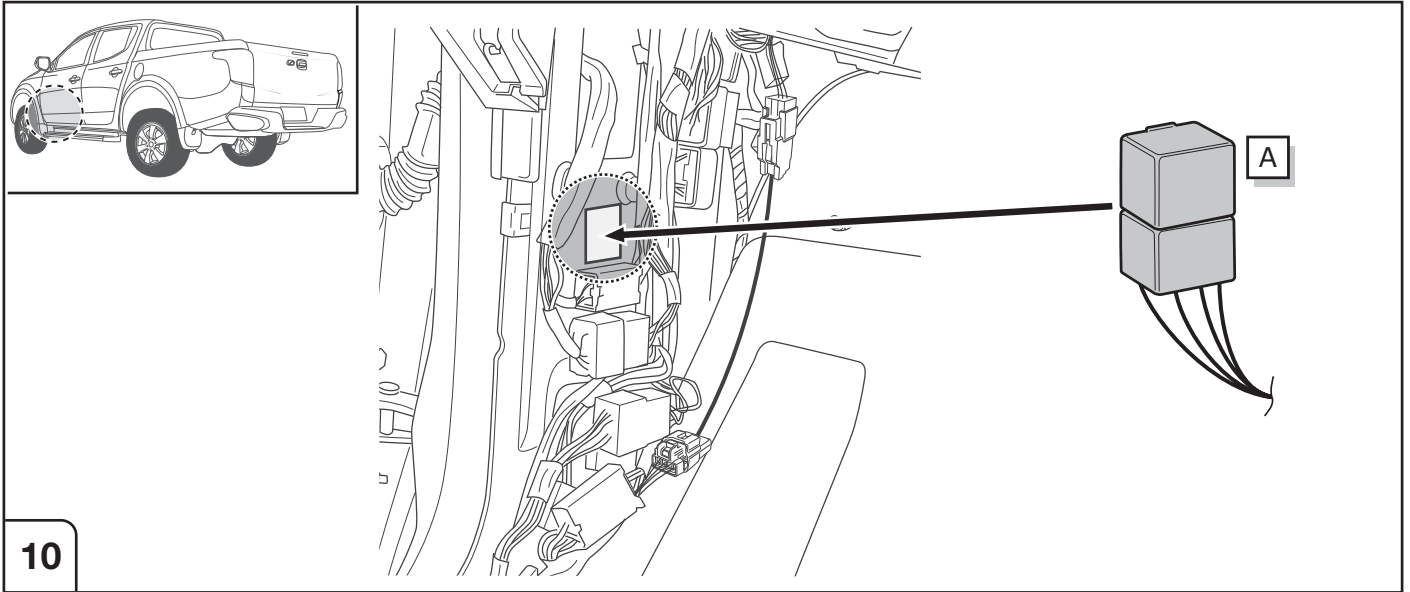
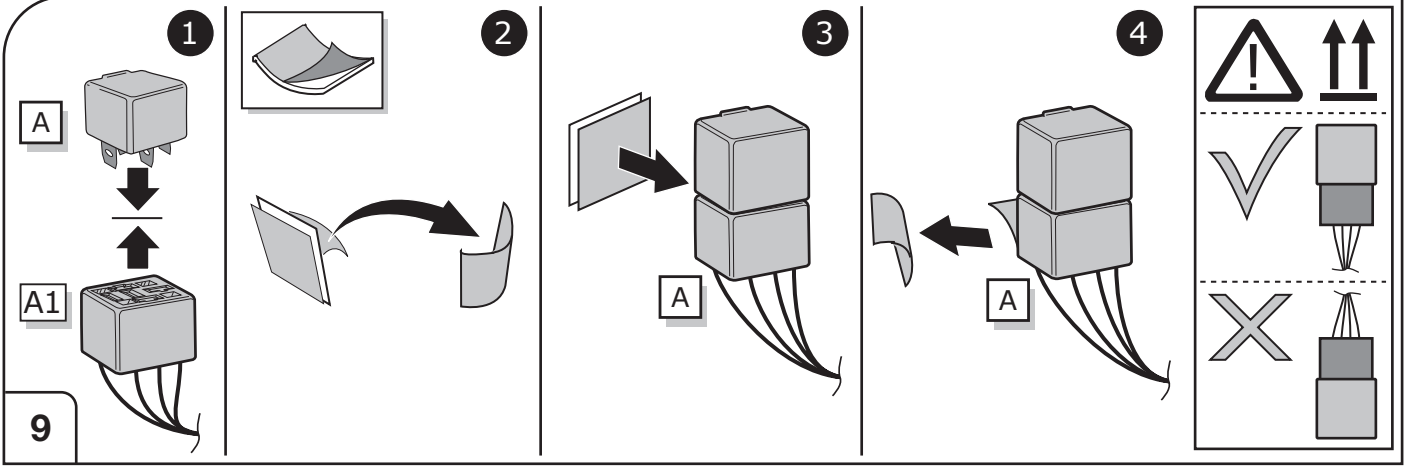

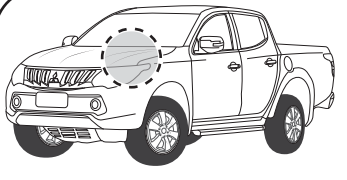

1

2

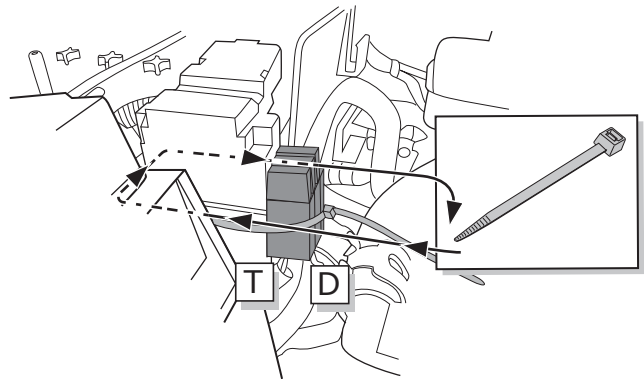
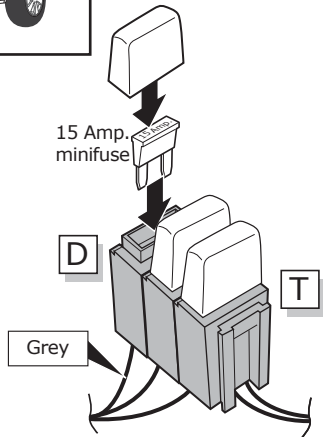
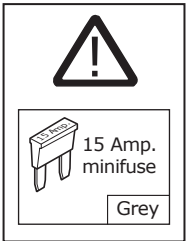

12

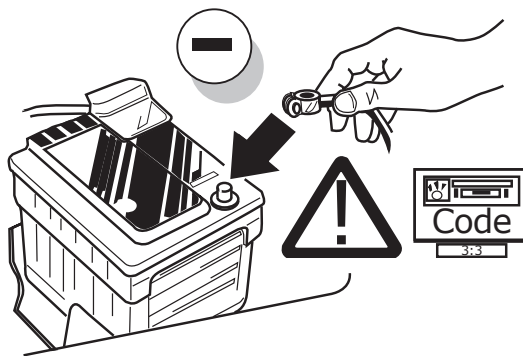

13

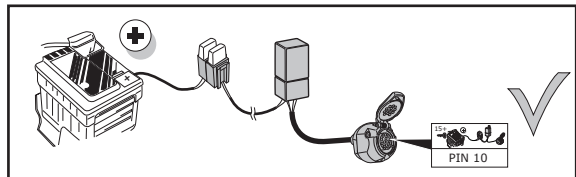
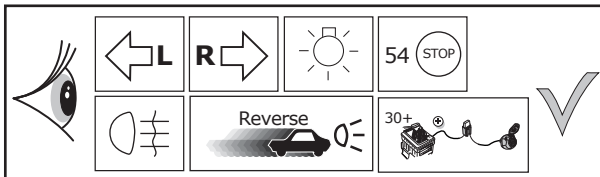
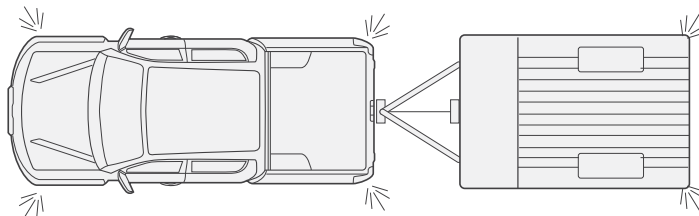

14

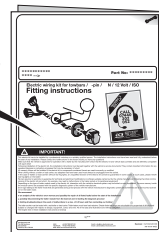
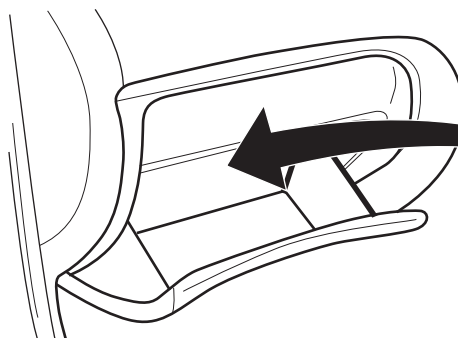

15